



ZASTOSOWANIE

Wentylator przeznaczony do wszelkiego rodzaju instalacji wentylacji ogólnej. Typowe zastosowania to:

- wentylacja wywiewna i nawiewna mieszkań, biur, sklepów, lokali gastronomicznych,
- układy chłodzące,
- nadmuchiwanie postaci reklamowych.

KONSTRUKCJA

- obudowa z blachy stalowej galwanizowanej, zabezpieczonej przed korozją poprzez malowanie farbą poliesterową,
- wirnik z tworzywa sztucznego (modele od 100 do 315),
- wirnik z blachy aluminiowej (modele 355 i 400),
- puszka przyłączeniowa na obudowie,
- wspornik montażowy na obudowie (modele od 100 do 315),
- możliwość montażu w pozycji pionowej i poziomej.

SILNIK ELEKTRYCZNY

- silniki jednofazowe 230V +/- 15%, 50/60Hz,
- stopień ochrony IP44, klasa izolacji uzwojenia B,
- do regulacji za pomocą potencjometru umieszczonego w puszcze przyłączeniowej,
- do regulacji za pomocą zewnętrznego potencjometru (zalecany REB ECOWATT),
- z możliwością sterowania sygnałem analogowym 0-10V,
- łożyska kulkowe,
- termiczne zabezpieczenie uzwojenia przed przeciążeniem.



Wspornik montażowy w standardzie
modele od 100 do 315



Modele 355 i 400

DANE TECHNICZNE

Typ	sygnał wejściowy	prędkość obrotowa	pobór mocy max	natężenie prądu	wydajność max	poziom ciśnienia akust.*			temp. pracy min max	masa	ErP	nr artykułu	
	[V]	[obr/min]	[W]	[A]	[m ³ /h]	wlot	emit.	wylot					
	[dB(A)]								[°C]	[kg]			
VENT-100 ECOWATT	10	2810	61	0,4	300	50	41	48	-20	+40	4	2018	40020993-01
	8	2325	41	0,3	250	47	38	43					
	6	1790	22	0,2	200	38	34	38					
	4	1310	12	0,1	150	31	29	31					
VENT-125 ECOWATT	10	2800	65	0,5	380	50	41	48	-20	+40	4	2018	40020993-02
	8	2330	46	0,3	330	46	38	44					
	6	1780	24	0,2	250	40	35	38					
	4	1275	12	0,1	180	32	29	31					
VENT-150 ECOWATT	10	2910	115	0,8	660	57	38	55	-20	+40	5	2018	40020993
	8	1550	80	0,6	580	54	38	52					
	6	1910	35	0,3	420	47	34	44					
	4	1360	16	0,1	300	37	24	35					
VENT-160 ECOWATT	10	2860	109	0,8	710	56	37	55	-20	+40	5	2018	40020994
	8	2430	70	0,5	590	53	40	52					
	6	1860	34	0,3	450	46	33	44					
	4	1330	16	0,1	320	37	28	36					
VENT-200 ECOWATT	10	2580	136	0,9	920	54	35	54	-20	+40	5	2018	40020995
	8	2260	92	0,7	800	49	32	50					
	6	1750	46	0,3	630	43	28	44					
	4	1300	22	0,2	450	36	24	36					
VENT-250 ECOWATT	10	2580	137	0,9	1030	56	39	57	-20	+40	6	2018	40020996
	8	2210	87	0,6	880	52	35	54					
	6	1740	45	0,3	700	45	29	49					
	4	1280	22	0,2	520	39	24	49					
VENT-315 ECOWATT	10	2160	184	1,2	1440	57	41	58	-20	+40	8	2018	40020997
	8	1940	136	0,9	1300	54	39	56					
	6	1590	76	0,5	1040	49	35	50					
	4	1190	35	0,2	790	42	28	44					
VENT-355 ECOWATT	10	1410	248	1	2620	53	43	55	-20	+40	17	2018	40020998
	8	1260	178	0,8	2310	50	39	52					
	6	1060	109	0,5	1940	47	36	48					
	4	860	63	0,3	1590	43	32	43					
VENT-400 ECOWATT	10	1400	376	1,6	3390	55	44	58	-20	+40	22	2018	40020999
	8	1240	266	1,1	3000	52	42	54					
	6	1050	162	0,7	2530	47	37	49					
	4	870	96	0,4	2070	41	33	43					

* pomiar z odległości 3m od wentylatora, przy 2/3 maksymalnej wydajności.

CHARAKTERYSTYKI PRACY I CHARAKTERYSTYKI AKUSTYCZNE

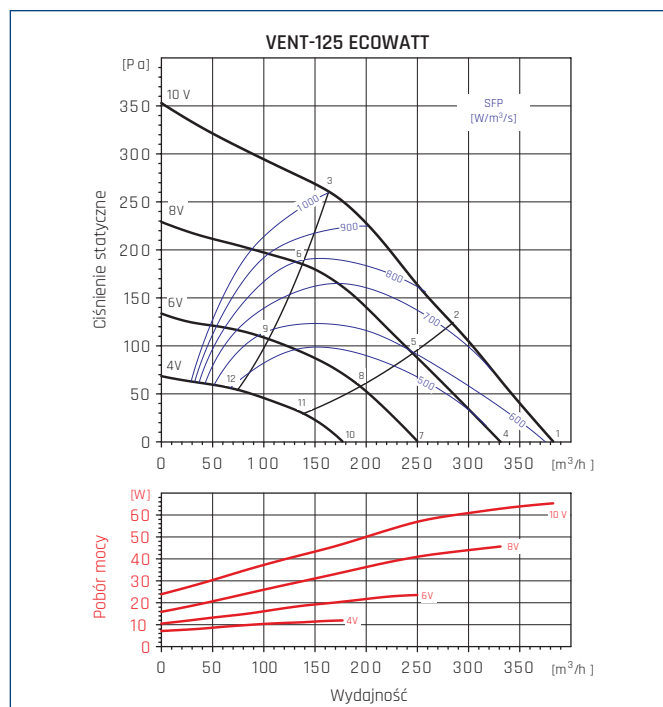
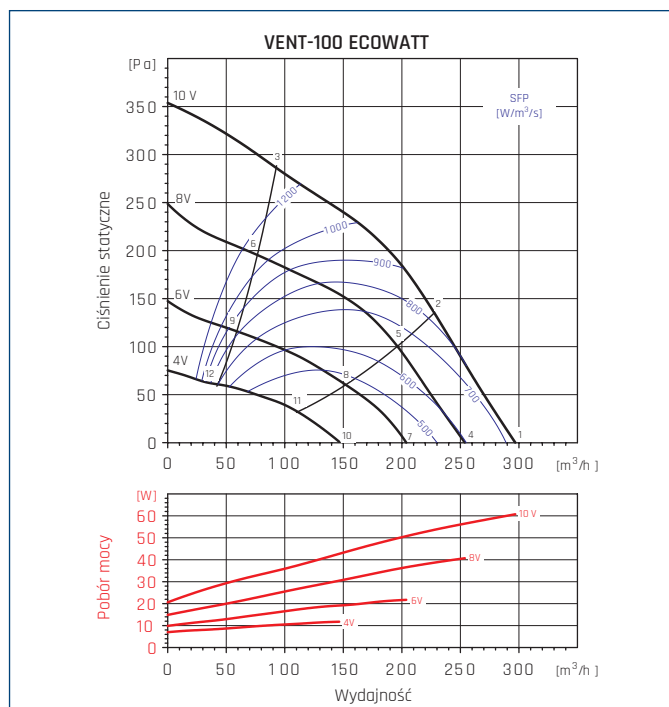

Częst. Hz/dB(A)	63	125	250	500	1000	2000	4000	8000	L _{WA}	
1	Wlot	42	53	62	65	68	63	53	44	71
	Wylot	41	52	67	64	61	63	54	46	71
	Emitowany	38	52	59	54	57	56	42	37	63
2	Wlot	39	48	58	64	67	62	52	44	70
	Wylot	38	47	61	62	60	62	51	40	68
	Emitowany	35	47	55	53	56	56	41	27	61
3	Wlot	10	46	56	63	65	60	53	48	68
	Wylot	10	46	56	62	58	59	49	39	65
	Emitowany	26	45	53	52	54	53	42	31	59
4	Wlot	40	50	59	63	65	59	50	40	68
	Wylot	38	47	63	60	56	57	49	39	66
	Emitowany	33	47	55	49	55	54	37	24	60
5	Wlot	36	45	55	63	63	57	48	40	67
	Wylot	33	42	57	60	54	55	44	33	63
	Emitowany	29	42	51	50	53	52	35	23	58
6	Wlot	29	40	56	62	60	55	49	43	66
	Wylot	27	42	52	58	51	52	42	33	61
	Emitowany	22	37	52	49	51	50	36	26	57
7	Wlot	35	42	52	55	56	50	39	29	60
	Wylot	42	50	56	54	50	49	40	29	60
	Emitowany	37	42	52	50	50	44	27	20	56
8	Wlot	32	41	50	54	54	48	38	30	58
	Wylot	42	50	53	53	48	47	35	25	58
	Emitowany	34	40	50	49	48	42	25	21	54
9	Wlot	29	40	49	52	51	46	39	32	56
	Wylot	42	50	49	50	46	45	32	25	56
	Emitowany	32	39	49	47	44	41	27	23	52
10	Wlot	31	38	45	47	49	40	28	23	52
	Wylot	30	44	48	47	44	40	28	23	52
	Emitowany	36	36	45	44	42	37	25	23	49
11	Wlot	29	38	45	46	48	39	28	24	51
	Wylot	29	45	45	46	43	39	25	23	51
	Emitowany	34	36	45	43	41	36	25	23	49
12	Wlot	21	36	43	43	46	40	29	24	50
	Wylot	28	42	43	44	42	39	25	23	49
	Emitowany	26	34	43	40	39	37	26	23	47

Częst. Hz/dB(A)	63	125	250	500	1000	2000	4000	8000	L _{WA}	
1	Wlot	39	48	60	66	69	65	56	44	72
	Wylot	43	49	66	65	63	64	56	46	71
	Emitowany	29	45	58	50	60	56	49	40	64
2	Wlot	37	45	57	64	66	62	52	40	70
	Wylot	38	45	62	63	62	60	53	42	68
	Emitowany	27	43	55	49	58	54	45	36	61
3	Wlot	31	46	61	65	66	61	50	40	70
	Wylot	35	42	58	64	61	60	52	43	67
	Emitowany	21	44	59	49	57	53	43	36	62
4	Wlot	36	45	56	64	65	61	52	39	69
	Wylot	39	46	62	62	59	58	51	41	67
	Emitowany	31	42	51	51	58	53	45	36	61
5	Wlot	34	42	53	61	62	58	47	35	66
	Wylot	34	42	58	60	57	55	47	36	64
	Emitowany	28	39	48	48	55	50	41	32	58
6	Wlot	27	39	59	61	60	56	44	33	66
	Wylot	27	38	62	59	55	54	46	39	65
	Emitowany	22	36	54	48	54	48	37	30	58
7	Wlot	31	45	54	57	58	53	43	30	62
	Wylot	42	42	56	55	52	50	42	30	60
	Emitowany	26	46	50	51	53	45	37	28	57
8	Wlot	28	44	54	54	55	49	38	26	60
	Wylot	42	41	53	53	50	47	37	26	58
	Emitowany	23	45	50	48	50	42	32	25	55
9	Wlot	25	40	52	54	54	48	35	25	59
	Wylot	42	42	53	52	49	46	36	28	57
	Emitowany	20	41	47	48	49	40	29	24	53
10	Wlot	30	42	47	48	49	42	32	24	54
	Wylot	30	41	49	47	46	41	30	23	53
	Emitowany	30	36	48	45	46	38	31	24	51
11	Wlot	27	39	46	46	47	39	29	23	52
	Wylot	29	41	47	45	45	39	27	23	51
	Emitowany	27	34	46	42	43	35	27	23	49
12	Wlot	28	43	44	45	46	38	28	23	51
	Wylot	29	41	46	44	45	38	27	23	50
	Emitowany	28	37	45	42	42	34	27	23	48

CHARAKTERYSTYKI PRACY I CHARAKTERYSTYKI AKUSTYCZNE

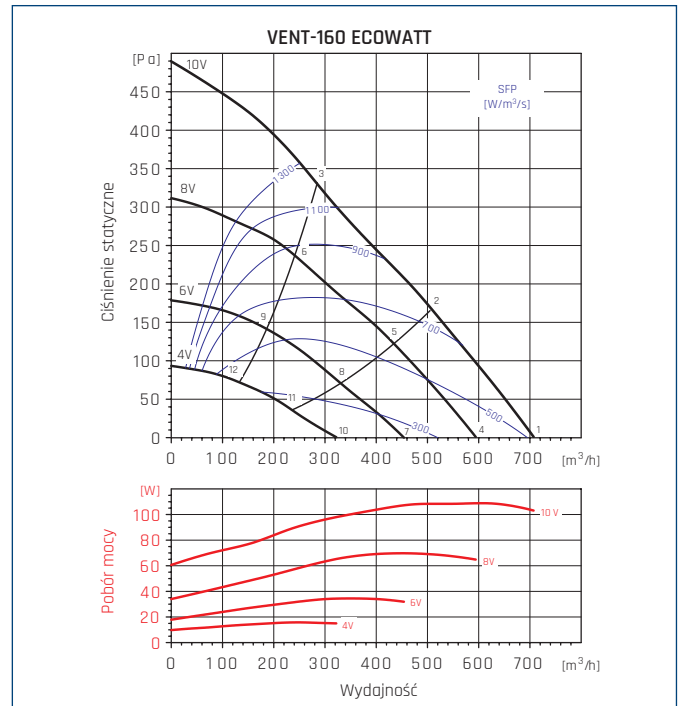
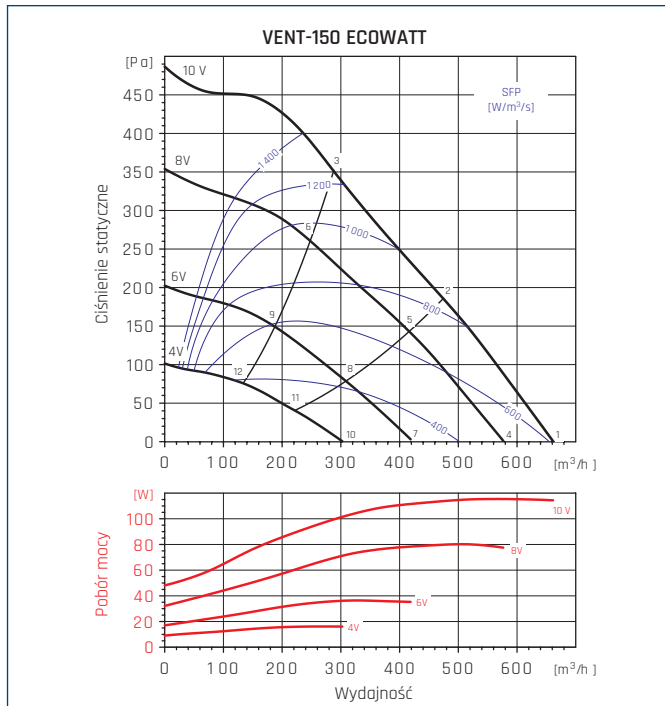

Częst. Hz/dB(A)		63	125	250	500	1000	2000	4000	8000	L _{WA}
1	Wlot	44	52	65	74	73	69	64	54	78
	Wylot	44	51	68	70	71	69	64	53	76
	Emitowany	28	39	45	47	54	56	47	36	59
2	Wlot	43	53	66	74	72	68	62	52	77
	Wylot	42	53	69	69	70	67	61	51	75
	Emitowany	27	40	46	47	53	54	44	34	58
3	Wlot	40	54	66	76	72	67	60	50	78
	Wylot	39	55	69	71	70	67	60	50	76
	Emitowany	24	41	46	49	53	53	43	32	57
4	Wlot	41	49	61	71	69	65	60	49	74
	Wylot	41	49	65	67	68	65	60	48	73
	Emitowany	32	42	47	53	52	54	46	35	58
5	Wlot	41	51	61	71	68	64	58	47	74
	Wylot	40	52	66	66	67	64	58	47	72
	Emitowany	32	43	48	53	51	53	44	33	58
6	Wlot	38	54	63	72	69	63	56	47	75
	Wylot	37	57	66	67	67	64	56	46	72
	Emitowany	27	46	48	53	51	52	42	32	58
7	Wlot	35	45	55	65	62	58	51	39	68
	Wylot	34	45	58	60	60	58	51	38	65
	Emitowany	29	41	42	49	47	51	38	26	55
8	Wlot	34	47	54	64	62	57	49	38	67
	Wylot	33	49	58	59	59	56	48	37	64
	Emitowany	29	43	41	48	47	50	35	25	54
9	Wlot	35	49	56	65	62	57	48	39	68
	Wylot	33	51	57	60	59	55	47	37	65
	Emitowany	29	45	43	48	47	49	35	26	54
10	Wlot	28	36	47	55	52	48	37	27	58
	Wylot	27	38	51	51	50	46	36	26	56
	Emitowany	23	30	35	41	40	36	26	24	45
11	Wlot	28	38	47	54	52	46	36	27	57
	Wylot	28	39	49	50	50	44	34	26	55
	Emitowany	24	31	34	40	39	34	25	23	44
12	Wlot	33	39	48	54	51	44	36	26	57
	Wylot	34	40	47	49	48	42	33	26	53
	Emitowany	28	32	36	39	38	32	25	23	44

Częst. Hz/dB(A)		63	125	250	500	1000	2000	4000	8000	L _{WA}
1	Wlot	41	50	64	74	73	69	65	54	78
	Wylot	41	49	67	71	71	69	65	54	76
	Emitowany	19	32	41	48	50	57	50	39	59
2	Wlot	43	50	64	72	71	68	62	51	76
	Wylot	41	50	69	69	70	68	62	51	75
	Emitowany	21	32	42	46	48	56	46	35	57
3	Wlot	41	53	63	74	71	66	60	49	76
	Wylot	40	55	67	70	69	66	60	49	74
	Emitowany	19	35	41	48	48	54	44	33	56
4	Wlot	39	47	61	71	69	66	61	49	74
	Wylot	39	46	64	67	67	66	61	49	73
	Emitowany	24	31	44	46	50	60	46	35	61
5	Wlot	38	48	60	70	68	65	59	47	73
	Wylot	38	49	64	66	66	66	58	46	72
	Emitowany	23	33	43	44	49	60	44	33	60
6	Wlot	37	48	57	66	63	60	52	41	69
	Wylot	36	50	59	62	61	61	51	41	67
	Emitowany	23	35	39	42	46	55	38	29	56
7	Wlot	33	42	54	65	61	58	53	39	67
	Wylot	32	44	56	61	60	60	52	39	65
	Emitowany	22	33	36	43	47	53	39	29	54
8	Wlot	32	46	53	63	61	57	49	37	66
	Wylot	32	49	56	59	59	59	49	37	64
	Emitowany	21	37	35	41	46	52	36	27	53
9	Wlot	33	42	50	58	55	54	44	32	61
	Wylot	33	44	52	54	53	55	42	32	60
	Emitowany	23	34	34	39	43	48	31	24	50
10	Wlot	25	38	48	55	52	51	40	28	58
	Wylot	26	37	50	51	50	52	38	27	57
	Emitowany	17	30	38	40	44	46	27	25	49
11	Wlot	27	39	45	53	51	51	38	27	57
	Wylot	28	39	48	49	49	52	36	26	56
	Emitowany	19	31	36	38	43	46	25	24	48
12	Wlot	31	39	44	52	49	50	38	26	56
	Wylot	32	38	46	47	47	51	35	26	54
	Emitowany	22	31	34	36	41	45	25	23	47

CHARAKTERYSTYKI PRACY I CHARAKTERYSTYKI AKUSTYCZNE

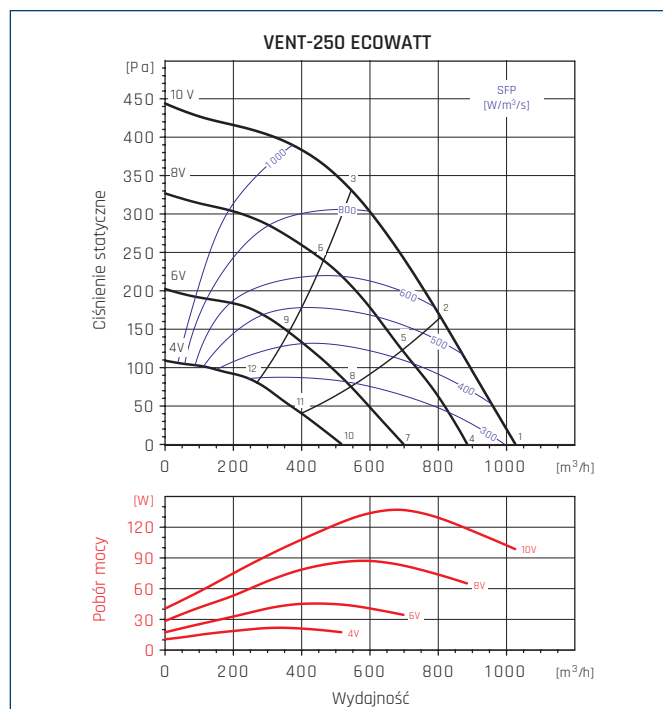
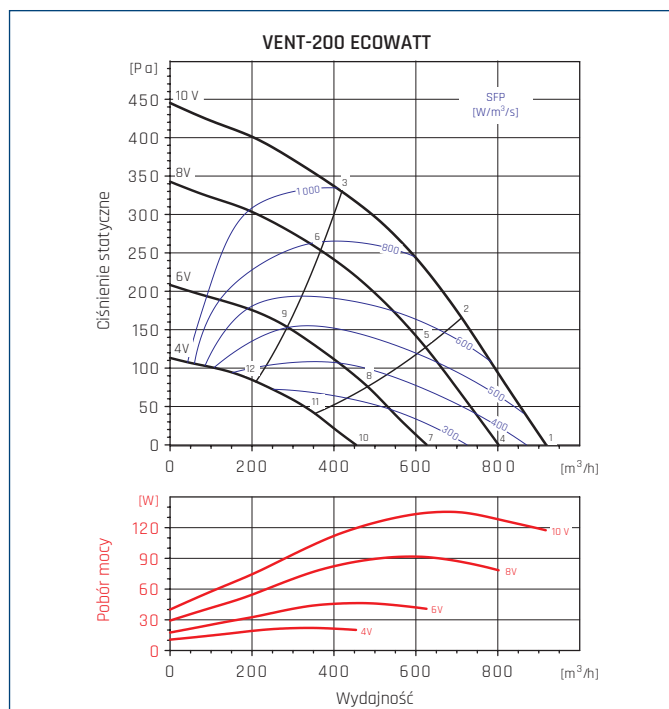

Częst. Hz/dB(A)		63	125	250	500	1000	2000	4000	8000	L _{WA}
1	Wlot	42	52	62	70	68	65	65	61	74
	Wylot	41	51	66	67	68	69	66	60	75
	Emitowany	30	36	40	48	46	53	48	43	56
2	Wlot	37	50	63	70	68	64	63	57	74
	Wylot	39	51	66	67	68	68	64	56	74
	Emitowany	25	34	41	49	46	51	46	40	55
3	Wlot	38	55	65	70	69	64	61	55	74
	Wylot	38	56	69	68	69	68	63	53	75
	Emitowany	26	40	43	49	47	51	44	37	55
4	Wlot	40	49	59	65	65	62	62	56	70
	Wylot	39	48	63	64	64	66	63	55	71
	Emitowany	36	38	40	45	43	51	46	40	54
5	Wlot	35	46	60	64	64	61	59	52	69
	Wylot	36	48	63	63	64	65	61	51	70
	Emitowany	30	36	40	44	42	49	43	36	52
6	Wlot	36	52	62	65	65	60	57	50	70
	Wylot	36	53	65	64	65	64	59	49	71
	Emitowany	32	42	42	45	43	48	41	34	52
7	Wlot	36	42	54	58	60	57	55	45	64
	Wylot	35	41	57	57	59	61	57	44	65
	Emitowany	30	30	40	38	39	47	41	35	50
8	Wlot	33	41	54	58	58	56	52	43	63
	Wylot	34	42	57	57	58	59	54	42	64
	Emitowany	27	29	40	37	38	46	38	32	48
9	Wlot	35	47	55	58	59	54	49	41	63
	Wylot	35	47	59	57	59	58	52	40	65
	Emitowany	29	34	42	38	38	45	35	30	48
10	Wlot	29	35	46	53	53	52	44	34	58
	Wylot	29	34	48	50	51	54	45	32	58
	Emitowany	25	27	35	35	39	44	35	32	46
11	Wlot	30	35	46	52	52	50	41	32	56
	Wylot	31	35	49	49	50	51	42	30	56
	Emitowany	26	27	35	34	37	41	32	30	44
12	Wlot	37	37	47	51	51	46	39	29	56
	Wylot	36	36	51	49	50	49	41	28	56
	Emitowany	33	29	36	33	37	37	30	27	43

Częst. Hz/dB(A)		63	125	250	500	1000	2000	4000	8000	L _{WA}
1	Wlot	39	52	63	73	73	70	68	62	78
	Wylot	40	52	65	73	73	74	70	63	79
	Emitowany	30	45	43	55	54	55	54	46	61
2	Wlot	36	52	61	71	71	68	67	59	76
	Wylot	38	52	64	71	71	72	68	60	77
	Emitowany	28	45	41	53	52	53	52	43	59
3	Wlot	38	54	64	68	68	64	63	55	73
	Wylot	39	57	66	70	69	69	64	56	75
	Emitowany	30	47	44	51	49	49	48	39	56
4	Wlot	37	50	60	69	70	66	64	57	74
	Wylot	38	51	62	73	70	70	66	58	76
	Emitowany	26	43	40	52	50	52	50	42	57
5	Wlot	34	49	58	67	68	64	62	53	72
	Wylot	36	51	61	70	68	68	64	54	74
	Emitowany	23	42	39	50	48	50	48	38	55
6	Wlot	37	51	60	64	65	61	58	50	69
	Wylot	38	54	63	67	65	65	60	50	72
	Emitowany	26	45	41	47	45	47	43	34	53
7	Wlot	33	45	56	61	63	60	58	46	67
	Wylot	35	44	62	69	64	64	60	47	72
	Emitowany	27	36	39	44	44	45	44	35	51
8	Wlot	31	43	54	59	61	58	54	44	65
	Wylot	33	43	58	66	62	63	57	45	69
	Emitowany	25	34	37	42	42	44	40	33	49
9	Wlot	38	44	55	57	58	55	50	40	63
	Wylot	38	44	57	62	60	60	52	41	66
	Emitowany	32	35	38	40	38	41	36	30	46
10	Wlot	30	37	50	56	56	53	46	34	61
	Wylot	35	44	62	69	64	64	60	47	72
	Emitowany	22	29	37	39	37	40	37	32	46
11	Wlot	35	38	48	54	55	51	43	32	59
	Wylot	33	43	58	66	62	63	57	45	69
	Emitowany	27	30	35	38	36	39	33	30	44
12	Wlot	35	38	47	51	52	48	39	29	56
	Wylot	38	44	57	62	60	60	52	41	66
	Emitowany	27	29	34	34	33	35	30	27	41

CHARAKTERYSTYKI PRACY I CHARAKTERYSTYKI AKUSTYCZNE

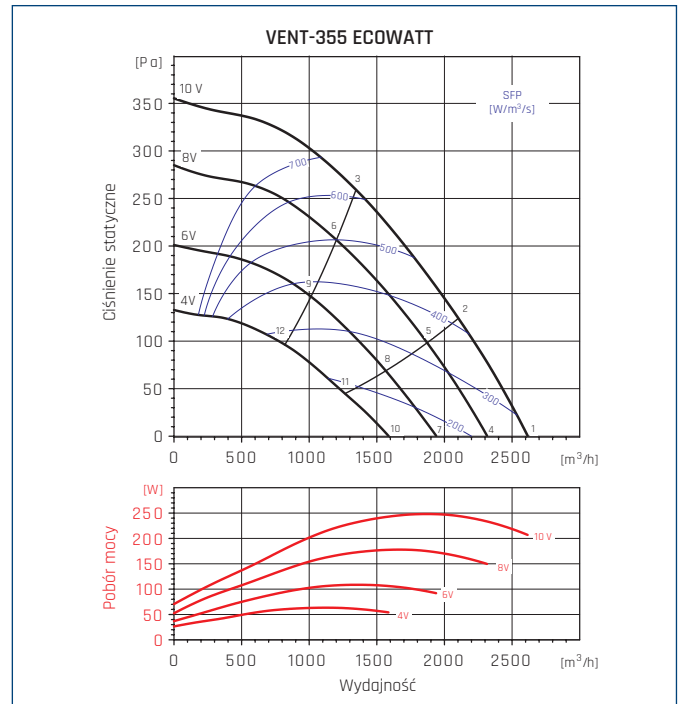
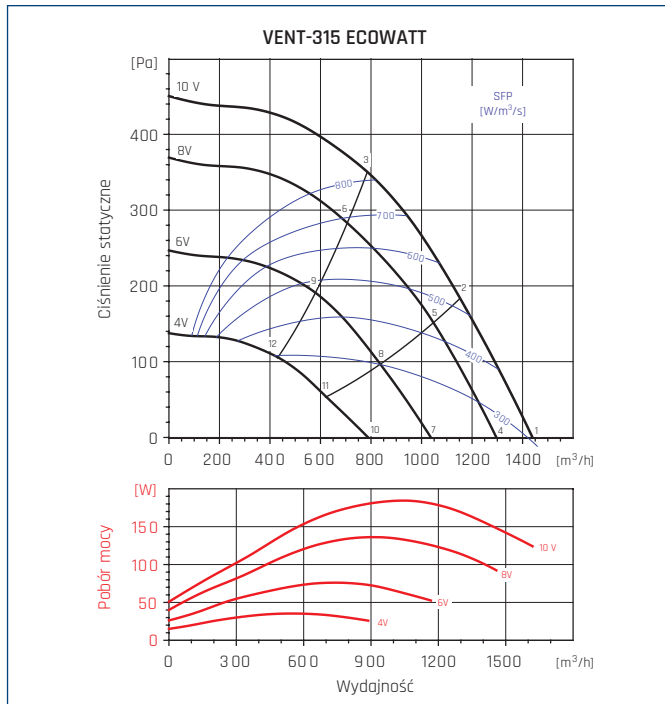

Czest. Hz/dB(A)		63	125	250	500	1000	2000	4000	8000	L _{WA}
1	Wlot	41	59	68	72	74	72	68	66	79
	Wylot	41	52	73	73	74	74	69	65	80
	Emitowany	28	39	43	55	56	58	55	50	63
2	Wlot	41	57	67	71	71	70	67	63	77
	Wylot	40	52	70	71	72	72	67	62	78
	Emitowany	27	40	42	53	54	57	54	47	61
3	Wlot	39	55	66	70	69	67	64	58	75
	Wylot	40	50	69	71	70	69	65	58	76
	Emitowany	26	38	41	53	52	54	52	42	59
4	Wlot	40	55	67	69	71	69	66	63	76
	Wylot	41	54	69	71	71	71	66	61	77
	Emitowany	31	39	42	53	54	56	54	48	61
5	Wlot	41	56	66	68	69	67	65	59	74
	Wylot	42	55	67	70	69	70	65	58	76
	Emitowany	32	40	40	52	52	54	53	44	59
6	Wlot	38	53	66	67	67	64	62	55	73
	Wylot	39	49	69	68	67	67	62	55	74
	Emitowany	29	38	41	51	49	52	50	40	57
7	Wlot	38	53	62	65	66	63	62	53	71
	Wylot	40	54	67	63	65	64	62	53	72
	Emitowany	27	39	42	49	50	51	51	38	57
8	Wlot	39	51	60	63	64	62	61	51	69
	Wylot	43	53	63	62	63	63	60	50	70
	Emitowany	28	38	40	48	49	50	50	35	55
9	Wlot	36	49	61	61	62	59	57	48	67
	Wylot	37	50	64	61	62	61	57	47	69
	Emitowany	24	36	41	46	46	47	46	33	53
10	Wlot	35	47	55	58	59	57	58	43	65
	Wylot	36	48	56	55	58	58	56	41	64
	Emitowany	27	36	36	44	44	45	47	34	52
11	Wlot	32	42	53	55	57	55	50	39	62
	Wylot	36	46	55	56	59	58	53	46	64
	Emitowany	25	31	34	42	41	44	39	30	48
12	Wlot	30	42	54	54	55	54	47	37	60
	Wylot	35	44	55	53	55	55	47	37	61
	Emitowany	23	31	35	40	40	42	36	28	46

Czest. Hz/dB(A)		63	125	250	500	1000	2000	4000	8000	L _{WA}
1	Wlot	40	58	68	72	68	66	61	52	75
	Wylot	42	61	70	72	74	69	61	53	78
	Emitowany	29	42	55	57	63	57	48	41	66
2	Wlot	38	56	65	70	66	63	57	49	73
	Wylot	40	59	68	70	72	66	57	50	75
	Emitowany	27	41	52	55	61	54	45	38	63
3	Wlot	40	58	60	65	61	59	53	46	69
	Wylot	40	58	60	65	61	59	53	46	69
	Emitowany	29	42	47	50	57	50	41	36	59
4	Wlot	38	60	64	69	66	63	56	48	72
	Wylot	39	64	63	69	71	66	57	49	75
	Emitowany	28	47	47	55	60	56	44	40	62
5	Wlot	36	57	61	67	63	59	53	44	70
	Wylot	37	61	60	66	68	62	53	45	72
	Emitowany	25	44	44	52	57	53	41	36	59
6	Wlot	38	56	57	62	58	55	49	41	65
	Wylot	37	59	57	62	64	59	50	42	68
	Emitowany	27	43	40	47	52	48	37	34	55
7	Wlot	35	59	61	67	61	59	51	42	69
	Wylot	36	63	59	66	66	61	51	42	71
	Emitowany	31	41	46	54	55	52	41	38	59
8	Wlot	33	56	59	64	58	56	48	39	67
	Wylot	34	58	56	64	63	58	47	39	68
	Emitowany	29	38	44	51	52	49	38	35	56
9	Wlot	34	53	54	58	53	52	44	36	62
	Wylot	33	55	53	59	59	54	44	36	64
	Emitowany	29	35	39	45	47	45	34	32	51
10	Wlot	32	48	60	62	56	52	44	35	65
	Wylot	32	49	59	62	60	55	43	36	66
	Emitowany	27	40	45	48	53	45	39	34	55
11	Wlot	30	47	58	60	52	49	40	33	63
	Wylot	32	47	57	59	57	51	40	33	63
	Emitowany	24	38	44	45	50	42	35	32	52
12	Wlot	30	46	53	56	49	45	37	31	59
	Wylot	31	48	52	56	55	48	37	31	60
	Emitowany	24	37	39	42	46	38	32	30	49

CHARAKTERYSTYKI PRACY I CHARAKTERYSTYKI AKUSTYCZNE

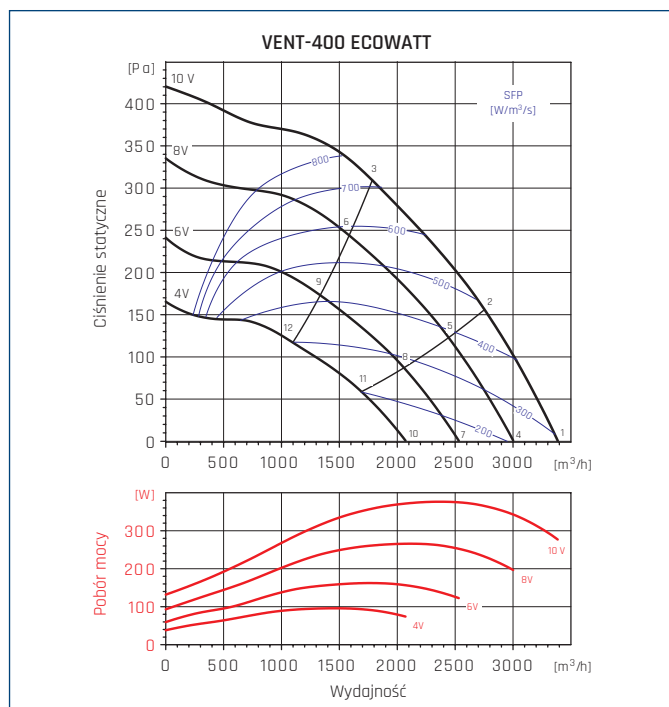

Częst. Hz/dB(A)		63	125	250	500	1000	2000	4000	8000	L _{WA}
1	Wlot	45	65	69	73	67	69	65	52	77
	Wylot	46	73	68	74	72	70	65	54	79
	Emitowany	39	55	57	59	61	57	49	37	65
2	Wlot	43	66	68	72	66	65	59	50	75
	Wylot	44	73	67	73	71	67	59	51	78
	Emitowany	37	56	56	58	59	54	44	35	64
3	Wlot	46	65	64	68	64	60	56	50	72
	Wylot	44	70	65	71	70	65	57	50	76
	Emitowany	40	55	52	55	57	49	41	34	61
4	Wlot	42	60	69	69	64	66	58	48	74
	Wylot	43	66	67	71	69	66	58	49	75
	Emitowany	35	55	57	57	59	55	42	33	64
5	Wlot	40	59	67	69	62	60	53	45	72
	Wylot	41	65	66	71	67	62	54	46	74
	Emitowany	33	54	55	56	57	49	38	30	62
6	Wlot	44	60	62	67	61	57	52	45	70
	Wylot	41	63	64	69	67	61	53	44	73
	Emitowany	37	54	51	54	56	46	37	31	60
7	Wlot	39	55	64	64	61	62	51	43	69
	Wylot	40	57	65	66	65	63	52	45	71
	Emitowany	32	48	53	51	55	51	35	30	59
8	Wlot	37	55	62	62	59	56	47	39	67
	Wylot	38	56	63	64	64	58	48	41	69
	Emitowany	30	47	52	49	53	44	32	27	57
9	Wlot	40	55	58	60	56	53	47	40	64
	Wylot	41	57	60	63	63	57	47	39	68
	Emitowany	34	48	47	47	50	41	32	27	55
10	Wlot	39	52	57	58	58	54	43	36	64
	Wylot	42	54	57	60	61	56	44	37	65
	Emitowany	39	46	47	46	53	42	31	29	55
11	Wlot	40	51	56	56	55	49	40	33	61
	Wylot	41	53	55	58	58	51	41	34	63
	Emitowany	39	45	46	44	49	37	28	26	53
12	Wlot	38	50	53	55	53	47	40	34	59
	Wylot	40	53	54	57	57	50	40	33	62
	Emitowany	37	45	43	43	47	35	28	26	51

WYMIARY [mm]

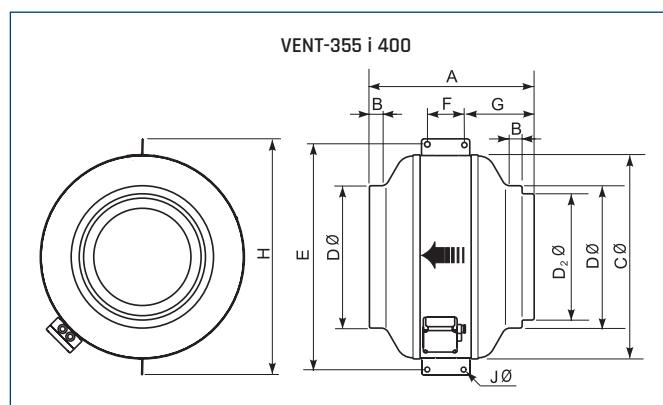
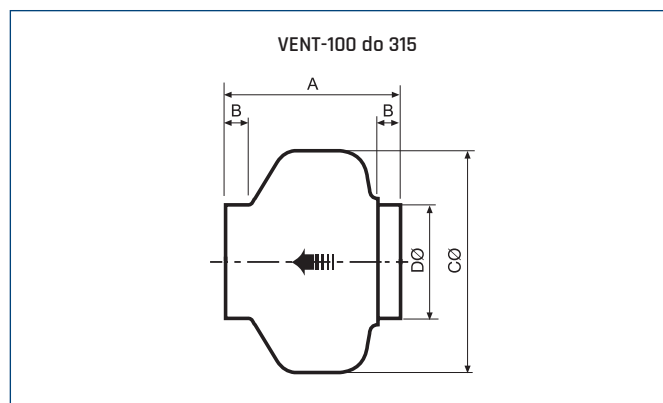

Typ	A	B	C	D	D2	E	F	G	H	J
VENT-100 ECOWATT	251	23	243	98						
VENT-125 ECOWATT	253	27	243	123						
VENT-150 ECOWATT	214	24	333	147						
VENT-160 ECOWATT	222	28	333	157						
VENT-200 ECOWATT	223	25	333	198						
VENT-250 ECOWATT	206	27	333	248						
VENT-315 ECOWATT	230	25	401	312						
VENT-355 ECOWATT	410	25	508	354	314	410	100	170	587	11
VENT-400 ECOWATT	441	25	568	399	354	441	100	185	647	11

AKCESORIA MONTAŻOWE



1 Wentylator	2 filtr kanałowy DF	3 filtr kanałowy DF-K				
		wkład filtracyjny do DF-K				EU9 I
		EU3	EU5 I	EU7 I	EU9 I	
VENT-100 ECOWATT	DF 100	DF-K 100	EU3 100-250mm	EU5 100-250mm	EU7 100-250mm	EU9 100-250mm
VENT-125 ECOWATT	DF 125	DF-K 125	EU3 100-250mm	EU5 100-250mm	EU7 100-250mm	EU9 100-250mm
VENT-150 ECOWATT	DF 160*	DF-K 160*	EU3 100-250mm*	EU5 100-250mm*	EU7 100-250mm*	EU9 100-250mm*
VENT-160 ECOWATT	DF 160	DF-K 160	EU3 100-250mm	EU5 100-250mm	EU7 100-250mm	EU9 100-250mm
VENT-200 ECOWATT	DF 200	DF-K 200	EU3 100-250mm	EU5 100-250mm	EU7 100-250mm	EU9 100-250mm
VENT-250 ECOWATT	DF 250	DF-K 250	EU3 100-250mm	EU5 100-250mm	EU7 100-250mm	EU9 100-250mm
VENT-315 ECOWATT	DF 315	DF-K 315	EU3 315-450mm	EU5 315-450mm	EU7 315-450mm	-
VENT-355 ECOWATT	DF 355	DF-K 355	EU3 315-450mm	EU5 315-450mm	EU7 315-450mm	-
VENT-400 ECOWATT	DF 400	DF-K 400	EU3 315-450mm	EU5 315-450mm	EU7 315-450mm	-

1 Wentylator	4 klapa zwrotna CAR-PL	5 złącze przeciwdrgan. ACOP PL	6 tłumik akustyczny AKU-COMP		7 przepustnica soczewk. IRIS	8 kratka wentylacyjna KWO	9 siatka ochronna DEF-VENT
			0,6m	1,2m			
VENT-100 ECOWATT	CAR-PL 100	ACOP PL 100	AKU-COMP 100/0.6	AKU-COMP 100/1.2	IRIS 100	KWO 100	DEF-VENT-100
VENT-125 ECOWATT	CAR-PL 125	ACOP PL 125	AKU-COMP 125/0.6	AKU-COMP 125/1.2	IRIS 125	KWO 125	DEF-VENT-125
VENT-150 ECOWATT	CAR-PL 150	ACOP PL 150	AKU-COMP 160/0.6*	AKU-COMP 160/1.2*	IRIS 160*	KWO 160	DEF-VENT-160*
VENT-160 ECOWATT	CAR-PL 160	ACOP PL 160	AKU-COMP 160/0.6	AKU-COMP 160/1.2	IRIS 160	KWO 160	DEF-VENT-160
VENT-200 ECOWATT	CAR-PL 200	ACOP PL 200	AKU-COMP 200/0.6	AKU-COMP 200/1.2	IRIS 200	KWO 200	DEF-VENT-200
VENT-250 ECOWATT	CAR-PL 250	ACOP PL 250	AKU-COMP 250/0.6	AKU-COMP 250/1.2	IRIS 250	KWO 250	DEF-VENT-250
VENT-315 ECOWATT	CAR-PL 315	ACOP PL 315	AKU-COMP 315/0.6	AKU-COMP 315/1.2	IRIS 315	KWO 315	DEF-VENT-315
VENT-355 ECOWATT	CAR-PL 355	ACOP PL 355	-	-	-	-	AFK 355
VENT-400 ECOWATT	CAR-PL 400	ACOP PL 400	-	-	IRIS 400	KWO 400	AFK 400

* akcesoria montażowe dedykowane do średnicy 160mm

Numery artykułów

ACOP PL 100	40521810	AKU-COMP 200/0.6	40521540	DEF-VENT-100	40522010	DF-K 100	40521710	IRIS 100	19527100
ACOP PL 125	40521815	AKU-COMP 200/1.2	40521640	DEF-VENT-125	40522011	DF-K 125	40521715	IRIS 125	19527125
ACOP PL 150	40521818	AKU-COMP 250/0.6	40521550	DEF-VENT-160	40522012	DF-K 160	40521720	IRIS 160	19527160
ACOP PL 160	40521820	AKU-COMP 250/1.2	40521650	DEF-VENT-200	40522013	DF-K 200	40521725	IRIS 200	19527200
ACOP PL 200	40521825	AKU-COMP 315/0.6	40521560	DEF-VENT-250	40522014	DF-K 250	40521730	IRIS 250	19527250
ACOP PL 250	40521830	AKU-COMP 315/1.2	40521660	DEF-VENT-315	40522015	DF-K 315	40521735	IRIS 315	19527315
ACOP PL 315	40521835	CAR-PL 100	40521010-01	AFK 355	40522133	DF-K 355	40521740	IRIS 400	19527400
ACOP PL 355	40521840	CAR-PL 125	40521020-01	AFK 400	40522134	DF-K 400	40521745	KWO 100	40522520
ACOP PL 400	40521845	CAR-PL 160	40521029-01	DF 100	40520610	EU3 100-250mm	40520800	KWO 125	40522530
AKU-COMP 100/0.6	40521510	CAR-PL 160	40521030-01	DF 125	40520620	EU3 315-450mm	40520830	KWO 160	40522540
AKU-COMP 100/1.2	40521610	CAR-PL 200	40521040-01	DF 200	40520640	EU5 100-250mm	40520805	KWO 200	40522550
AKU-COMP 125/0.6	40521520	CAR-PL 250	40521050-01	DF 250	40520650	EU5 315-450mm	40520835	KWO 250	40522560
AKU-COMP 125/1.2	40521620	CAR-PL 315	40521060-01	DF 315	40520660	EU7 100-250mm	40520810	KWO 315	40522570
AKU-COMP 160/0.6	40521530	CAR-PL 355	40521065-01	DF 355	40520670	EU7 315-450mm	40520840	KWO 400	40522580
AKU-COMP 160/1.2	40521630	CAR-PL 400	40521070-01	DF 400	40520675	EU9 100-250mm	40520820		

filtr DF	zest. filtr. DFK...+EU	klapa zwrotna CAR-PL	złącze p-drg. ACOP-PL	tłumik AKU-COMP	przepustnica IRIS	kratka KWO	anemostat AKT/AKK	siatka ochr. DEF-VENT	nagrzewnica DH/DH-R

AKCESORIA ELEKTRYCZNE

Wentylator	termostat ścienny	termostat kanałowy	czujnik zanieczyszcz.	higrostat	regulator
	TS	TK-1	SQA	HIG-2	REB-ECOWATT
VENT-100 ECOWATT	TS	TK-1	SQA	HIG-2	REB-ECOWATT
VENT-125 ECOWATT	TS	TK-1	SQA	HIG-2	REB-ECOWATT
VENT-150 ECOWATT	TS	TK-1	SQA	HIG-2	REB-ECOWATT
VENT-160 ECOWATT	TS	TK-1	SQA	HIG-2	REB-ECOWATT
VENT-200 ECOWATT	TS	TK-1	SQA	HIG-2	REB-ECOWATT
VENT-250 ECOWATT	TS	TK-1	SQA	HIG-2	REB-ECOWATT
VENT-315 ECOWATT	TS	TK-1	SQA	HIG-2	REB-ECOWATT
VENT-355 ECOWATT	TS	TK-1	SQA	HIG-2	REB-ECOWATT
VENT-400 ECOWATT	TS	TK-1	SQA	HIG-2	REB-ECOWATT

Numery artykułów

HIG-2	40025150	REB-ECOWATT	40025005	SQA	40025140	TK-1	40025330	TS	40025345
-------	----------	-------------	----------	-----	----------	------	----------	----	----------

				
termostat TS	termostat TK-1	czujnik SQA	higrostat HIG-2	regulator REB ECOWATT

CHARAKTERYSTYKA ERP

SWNM*						
	Nazwa produktu	VENT-100 ECOWATT	VENT-125 ECOWATT	VENT-150 ECOWATT	VENT-160 ECOWATT	VENT-200 ECOWATT
a	Nazwa dostawcy	VENTURE INDUSTRIES	VENTURE INDUSTRIES	VENTURE INDUSTRIES	VENTURE INDUSTRIES	VENTURE INDUSTRIES
b	Numer artykułu	40020993-01	40020993-02	40020993	40020994	40020995
c	Kategoria urządzenia	SWNM (NRVU)	SWNM (NRVU)	SWNM (NRVU)	SWNM (NRVU)	SWNM (NRVU)
c	Typ urządzenia	JSW (UVU)	JSW (UVU)	JSW (UVU)	JSW (UVU)	JSW (UVU)
d	Napęd	bezstopniowy	bezstopniowy	bezstopniowy	bezstopniowy	bezstopniowy
e	Typ odzysku ciepła	brak	brak	brak	brak	brak
f	Sprawność temperaturowa [%]	nie dotyczy	nie dotyczy	nie dotyczy	nie dotyczy	nie dotyczy
g	Znamionowe natężenie przepływu w SWNM w [m ³ /s]	0,04	0,049	0,07	0,084	0,116
h	Efektywny pobór mocy w (kW)	0,042	0,046	0,094	0,094	0,115
i	JMWint w W/(m ³ /s)	1,06	0,95	1,34	1,15	0,99
j	Prędkość czołowa w m/s	0,9	1,1	0,8	1	1,3
k	Δps, ext (Pa)	263	263	395	329	339
l	Δps, int (Pa)	nie dotyczy	nie dotyczy	nie dotyczy	nie dotyczy	nie dotyczy
m	Δps, add (Pa)	nie dotyczy	nie dotyczy	nie dotyczy	nie dotyczy	nie dotyczy
n	Sprawność statyczna wentylatora [%]	23,1	26,5	28,7	27,5	33,5
o	Stopień zewn. przecieków powietrza [%]	3	3	3	3	3
p	Stopień wewn. przecieków powietrza [%]	nie dotyczy	nie dotyczy	nie dotyczy	nie dotyczy	nie dotyczy
q	Efektywność energetyczna filtra	nie dotyczy	nie dotyczy	nie dotyczy	nie dotyczy	nie dotyczy
r	Ostrzeżenia o konieczności wymiany filtra	nie dotyczy	nie dotyczy	nie dotyczy	nie dotyczy	nie dotyczy
s	L _{WA} dB(A)	59	62	57	56	55
	Strona internetowa	www.venture.pl	www.venture.pl	www.venture.pl	www.venture.pl	www.venture.pl

SWNM*					
	Nazwa produktu	VENT-250 ECOWATT	VENT-315 ECOWATT	VENT-355 ECOWATT	VENT-400 ECOWATT
a	Nazwa dostawcy	VENTURE INDUSTRIES	VENTURE INDUSTRIES	VENTURE INDUSTRIES	VENTURE INDUSTRIES
b	Numer artykułu	40020996	40020997	40020998	40020999
c	Kategoria urządzenia	SWNM (NRVU)	SWNM (NRVU)	SWNM (NRVU)	SWNM (NRVU)
c	Typ urządzenia	JSW (UVU)	JSW (UVU)	JSW (UVU)	JSW (UVU)
d	Napęd	bezstopniowy	bezstopniowy	bezstopniowy	bezstopniowy
e	Typ odzysku ciepła	brak	brak	brak	brak
f	Sprawność temperaturowa [%]	nie dotyczy	nie dotyczy	nie dotyczy	nie dotyczy
g	Znamionowe natężenie przepływu w SWNM w [m ³ /s]	0,129	0,23	0,34	0,46
h	Efektywny pobór mocy w (kW)	0,117	0,182	0,223	0,349
i	JMWint w W/(m ³ /s)	0,91	0,79	0,65	0,76
j	Prędkość czołowa w m/s	1,5	1,8	1,7	1,8
k	Δps, ext (Pa)	369	342	284	334
l	Δps, int (Pa)	nie dotyczy	nie dotyczy	nie dotyczy	nie dotyczy
m	Δps, add (Pa)	nie dotyczy	nie dotyczy	nie dotyczy	nie dotyczy
n	Sprawność statyczna wentylatora [%]	40,1	42,6	42,1	42,9
o	Stopień zewn. przecieków powietrza [%]	3	3	3	3
p	Stopień wewn. przecieków powietrza [%]	nie dotyczy	nie dotyczy	nie dotyczy	nie dotyczy
q	Efektywność energetyczna filtra	nie dotyczy	nie dotyczy	nie dotyczy	nie dotyczy
r	Ostrzeżenia o konieczności wymiany filtra	nie dotyczy	nie dotyczy	nie dotyczy	nie dotyczy
s	L _{WA} dB(A)	56	63	59	60
	Strona internetowa	www.venture.pl	www.venture.pl	www.venture.pl	www.venture.pl

* SWNM-"system wentylacyjny przeznaczony do budynków niemieszkalnych"-zgodnie z Rozporządzeniem Komisji (UE) nr 1253/2014